

Section 8100 Index

BULLS-EYE SIGHT FEED VALVES UNIVERSAL42



Ruggedly constructed, provide adjustable, visible flow control on pressurized or gravity feed systems. Units selected according to piping arrangement and are used where considerable capacity of fluid must be dispensed.

FULL VISION FLOW SIGHTS49 OVERFLOW SIGHTS49



Full Vision Flow sights provide visible flow and are used on gravity or pressurized oil lines. Overflow Sight provide constant visible oil level for circulating oil systems.

MULTIPLE SIGHT FEED VALVES44

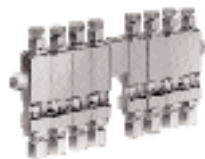

Provide adjustable, visible flow control to widely separated points from one central location. Used on pressurized or gravity feed systems. Select according to number of locations to be lubricated.

PRECISION RELIEF VALVES47



Precision Relief Valves provide safety where certain maximum pressure should not be exceeded. Units are adjustable.

SHUTOFF VALVES47



Provide rapid, positive open/closed action. Operates in any position and are compact in size. Offered with either toggle or solenoid shutoff controls.

SIGHT FEED VALVES WITH SHUT-OFFS45



Provide adjustable, visible flow control. Straight pattern regulates liquid flow from full flow to complete shutoff. Toggle and solenoid shutoff provide complete shutoff while retaining flow setting.

SMALL SIGHT FEED VALVES43



Provides adjustable, visible flow control on pressurized or gravity feed systems. Units are selected according to piping arrangement requirements.

SOLENOID VALVE OPERATORS46 CONSTANT FLOW CONTROL VALVES46



Solenoid operators are available in all voltages and frequencies. Constant flow control valves provide a fixed flow rate and are used in low pressure lubricating systems.

WINDOW FLOW SIGHTS48



Flow sight with restrictive orifices provide a visible fixed flow rate which can be selected according to orifice size. Full flow sights provide a visible flow with no restrictions to flow rate.

Universal Sight Feed Valves

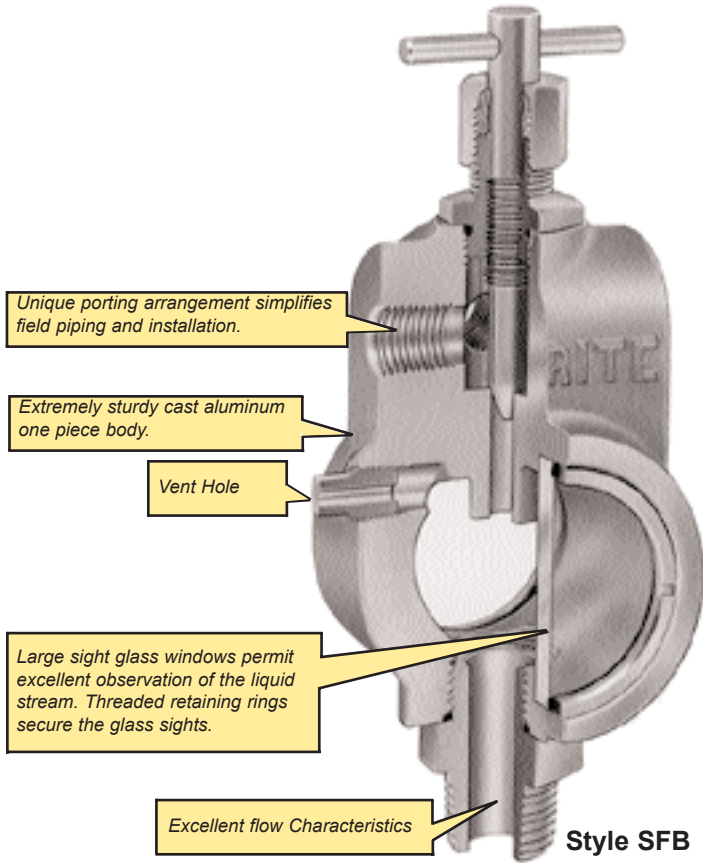

UNIVERSAL PATTERN BULLS-EYE SIGHT FEED VALVES allow visual observation of the liquid stream from a distance, with the volume of flow controlled by an adjustable needle valve. The Bulls-eye sight feed valve has excellent flow characteristics with low pressure drop.

These units are principally used on gravity or pressure oiling systems of larger machinery for lubrication where considerable capacities of oil must be dispensed. The rugged, sturdy construction makes them especially suitable for paper mill machinery, steel mills, rolling mills, sugar mills, steam and gas engines, gear units, etc. Their use can be extended to any application requiring adjustable, visible flow control.

Large sight glass windows on both sides of the valve are properly gasketed to prevent leakage and permit an excellent observation of the liquid stream. The sights can easily be removed for cleaning or replacement without disconnecting the valve. Threaded retaining rings on both sides secure the glass with full circumferential support for excellent sight pressure integrity.

The unique features of this valve is the porting arrangement, which allows the user to select several combinations of patterns to simplify field piping and installation.

When Ordering Specify:

- Catalog Number

SPECIFICATIONS:

- Pressure 125 P.S.I. Inlet to Orifice
55 P.S.I. Sight Chamber
Maximum with Vent Sealed
- Valve Body Aluminum, Gold Anodized
- Needle Ass'y Steel, Plated
- Sight Glass
- Seals Buna-N
- Temperature 225° F. Maximum
- Port 1/4 Dia.
- Sight 1 1/2 Dia.

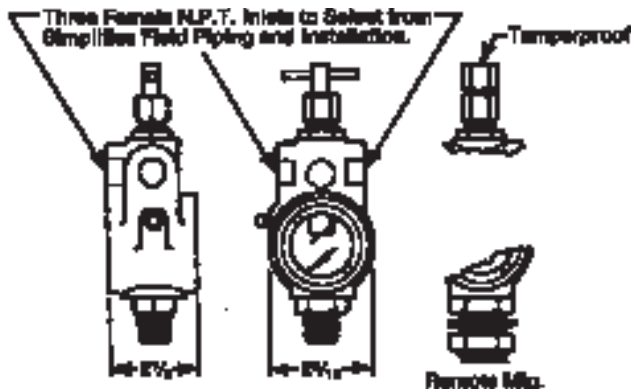
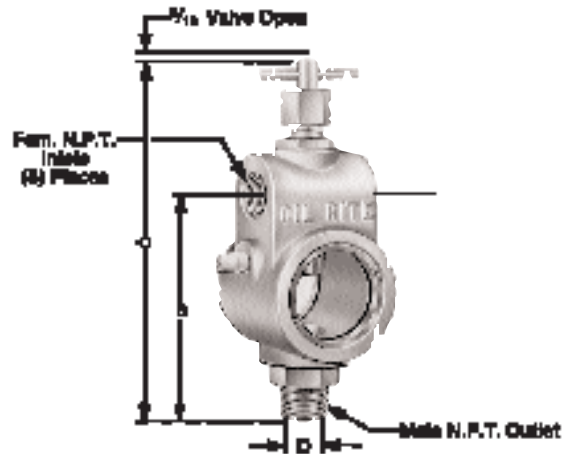

Catalog Number	Body Style	Inlet N.P.T.	B	C	D	Outlet N.P.T.
B-2501-1	T-Handle	1/4	4	6 ^{11/32}	5/16	1/4
B-2501-2		3/8			7/16	3/8
B-2501-3		1/2			1/2	1/2
B-2501-4		1/2			9/16	3/4
B-2501-5	Tamperproof	1/4	4	6 ^{11/32}	5/16	1/4
B-2501-6		3/8			7/16	3/8
B-2501-7		1/2			1/2	1/2
B-2501-8		1/2			9/16	3/4

Also Available in Remote Mounting

Small Sight Feed Valves

Needle valve regulates liquid flow from full flow to a complete shutoff.

Precision flow control for fine metering of liquids.

Large vented sight chambers are provided for easily observing the flow of liquid.

Body machined from solid bar stock resulting in sturdy and compact designs.

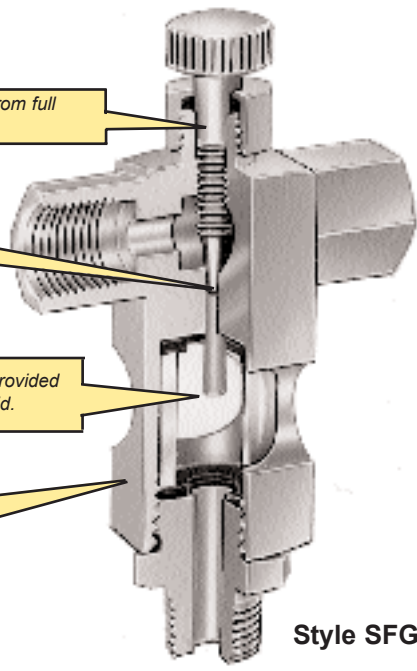

Style SFG

SMALL SIGHT FEED VALVES control the volume of liquid being dispensed while permitting visual observation of liquid flow. The valves are primarily used on gravity or pressure oiling systems for bearing lubrication on machinery. Their use can be extended to any application requiring adjustable, visible, flow control. They are equipped with needle valve control that regulates liquid flow from full flow to a complete shutoff.

The valves are available with a conventional exposed adjustment, but can be provided with tamperproof construction. The construction is rugged and sturdy. The bodies are made of plated steel. The sight glass is firmly held between two seals, a solid one at the bottom and a split one on top for venting. The purpose of the vent is to eliminate any air block which might occur in some applications which develop a suction or back pressure.

There are some applications under which vacuum or pressure must be maintained on the discharge side of a valve. For applications requiring air tight sight chambers, solid gaskets can be provided.

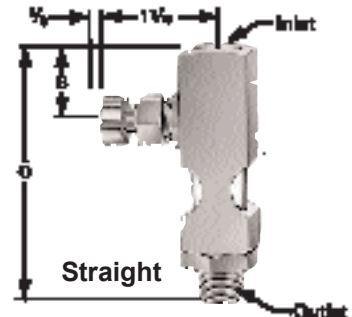

Straight

SPECIFICATIONS:

- Pressure 125 P.S.I. Inlet to Orifice Sight Chamber is Vented
- Temperature 225° F. Maximum
- Port 1/16 Dia.
- Sight Glass Steel, Plated, 5/8 Sq.
- Body Steel, Plated, 5/8 Sq.
- Seals Buna-N

When Ordering Specify:

- Catalog Number

Catalog Number	Inlet N.P.T.	Outlet N.P.T.	B	C
B-1631-1	1/8 Fem.	1/8 Fem.	19/32	2 ⁹ / ₃₂
B-1631-2	1/8 Male	1/8 Male		2 ¹³ / ₃₂
B-1631-3	1/8 Fem.	1/8 Male		2 ¹³ / ₃₂
B-1631-4	1/8 Male	1/8 Fem.		2 ⁹ / ₃₂
B-1631-5	1/8 Fem.	1/4 O.D. Tube		2 ¹¹ / ₁₆
B-1631-6	1/8 Male	1/4 O.D. Tube		2 ¹¹ / ₁₆
B-1631-13	1/8 Fem.	Remote		2 ³¹ / ₃₂

Also Available w/1/4 N.P.T. and Tamperproof

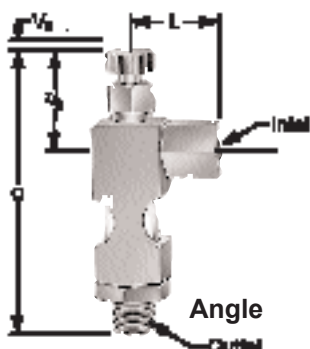

Angle

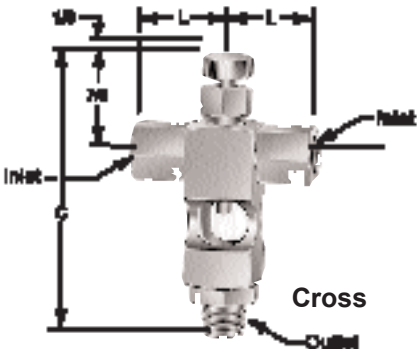

Cross

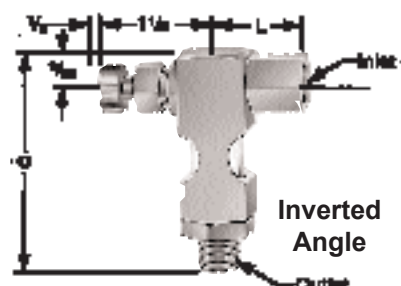

Inverted Angle

Catalog Number	Inlet N.P.T.	Outlet N.P.T.	C	L
B-1628-1	1/8 Fem.	1/8 Fem.	2 ⁹ / ₁₆	13/16
B-1628-2	1/8 Male	1/8 Male	2 ¹¹ / ₁₆	
B-1628-3	1/8 Fem.	1/8 Male	2 ¹¹ / ₁₆	
B-1628-4	1/8 Male	1/8 Fem.	2 ⁹ / ₁₆	
B-1628-5	1/8 Fem.	1/4 O.D. Tube	3	
B-1628-6	1/8 Male	1/4 O.D. Tube	3	
B-1628-13	1/8 Fem.	Remote	3	

Also Available w/1/4 N.P.T. and Tamperproof

Catalog Number	Inlet N.P.T.	Outlet N.P.T.	C	L
B-1629-1	1/8 Fem.	1/8 Fem.	2 ⁹ / ₁₆	13/16
B-1629-2	1/8 Male	1/8 Male	2 ¹¹ / ₁₆	
B-1629-3	1/8 Fem.	1/8 Male	2 ¹¹ / ₁₆	
B-1629-4	1/8 Male	1/8 Fem.	2 ⁹ / ₁₆	
B-1629-5	1/8 Fem.	1/4 O.D. Tube	3	
B-1629-6	1/8 Male	1/4 O.D. Tube	3	
B-1629-13	1/8 Fem.	Remote	3	

Also Available w/1/4 N.P.T. and Tamperproof

Catalog Number	Inlet N.P.T.	Outlet N.P.T.	C	L
B-1630-1	1/8 Fem.	1/8 Fem.	1 ³¹ / ₃₂	13/16
B-1630-2	1/8 Male	1/8 Male	2 ³ / ₃₂	
B-1630-3	1/8 Fem.	1/8 Male	2 ³ / ₃₂	
B-1630-4	1/8 Male	1/8 Fem.	1 ³¹ / ₃₂	
B-1630-5	1/8 Fem.	1/4 O.D. Tube	2 ³ / ₈	
B-1630-6	1/8 Male	1/4 O.D. Tube	2 ³ / ₈	
B-1630-13	1/8 Fem.	Remote	2 ²¹ / ₃₂	

Also Available w/1/4 N.P.T. and Tamperproof

Small Sight Feed Valves



Multiple Sight Feed Valves

Needle valve assembly permits fine adjustment over the entire range, from extremely low drop rate to a stream.

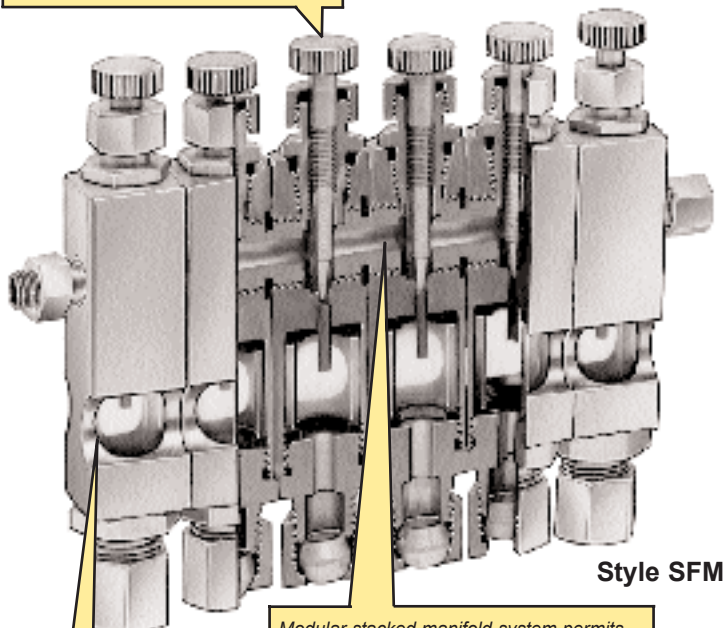

Style SFM

Modular stacked manifold system permits feeding of liquid to widely separated points.

Generous sight viewing glass.

MULTIPLE SIGHT FEED VALVES permit feeding of liquids to widely separated points, controlled and observed from one central location. They are suitable for gravity or pressure lubricating systems. These valves are used in a variety of industries: chemical, mining, paper, agricultural, marine, woodworking, textile, and can be used to lubricate typical equipment like pumps, compressors, machine tools, bearings, seals, punch presses and rollers.

A revolutionary principle regarding the assembly of these valves has been incorporated. The customer, for the first time, has the option of changing the unit in the field by merely stacking them together, eliminating the costly tie-rod and manifold method.

Very compact, the multiple valves require only the minimum amount of space making the valves especially suitable for lubricating inaccessible places.

Construction is extremely sturdy using a $\frac{5}{8}$ " square aluminum alloy. "O" rings between the valves form a positive seal. The generous sight viewing glass is firmly held between two gaskets. Buna-N seals are furnished throughout and are suitable in operation for 225° F. and 125 P.S.I. maximum. The valve assembly is provided with a single $\frac{1}{4}$ " female N.P.T. inlet, and the outlets are equipped with $\frac{1}{4}$ " O.D. tube fittings.

The sight chamber of the valve is equipped with a vent. The purpose of this vent is to eliminate any air block which might occur in some applications which develop a suction or back pressure.

Modification for special applications can also be furnished such as solenoid actuation, special gasket material and other materials.

SPECIFICATIONS:

- Pressure 125 P.S.I. Inlet to Orifice Sight Chamber is Vented
- Temperature 225° F. Maximum
- Port $\frac{1}{16}$ Dia.

- Valve Body Aluminum Alloy $\frac{5}{8}$ Sq.
- Sight Glass
- Seals Buna-N

When Ordering Specify:

- Catalog Number
- Additional Valves Specify Part Number B-3151-1

Connector Kit A-5671-1

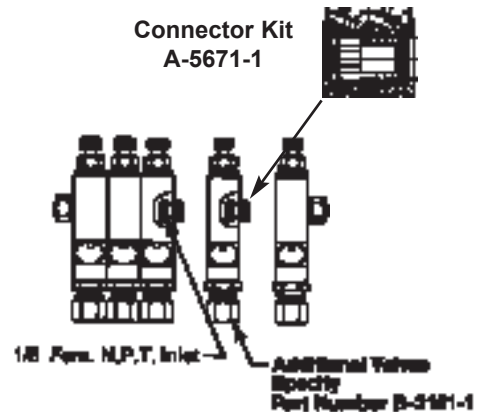

Catalog Number	No. of Feeds	L	M
B-3150-2	2	1 $\frac{1}{2}$	3
B-3150-3	3		3 $\frac{3}{4}$
B-3150-4	4	2 $\frac{1}{4}$	4 $\frac{1}{2}$
B-3150-5	5		5 $\frac{1}{4}$
B-3150-6	6		6
B-3150-7	7	3	6 $\frac{3}{4}$
B-3150-8	8		7 $\frac{1}{2}$
B-3150-9	9	3 $\frac{3}{4}$	8 $\frac{1}{4}$
B-3150-10	10		9
B-3150-11	11	4 $\frac{1}{2}$	9 $\frac{3}{4}$
B-3150-12	12		10 $\frac{1}{2}$
B-3150-13	13	5 $\frac{1}{4}$	11 $\frac{1}{4}$
B-3150-14	14		12
B-3150-15	15	6	12 $\frac{3}{4}$
B-3150-16	16		13 $\frac{1}{2}$
B-3150-17	17	6 $\frac{3}{4}$	14 $\frac{1}{4}$
B-3150-18	18		15
B-3150-19	19	7 $\frac{1}{2}$	15 $\frac{3}{4}$
B-3150-20	20		16 $\frac{1}{2}$
B-3150-21	21	8 $\frac{1}{4}$	17 $\frac{1}{4}$
B-3150-22	22		18
B-3150-23	23	9	18 $\frac{3}{4}$
B-3150-24	24	9 $\frac{3}{4}$	19 $\frac{1}{2}$

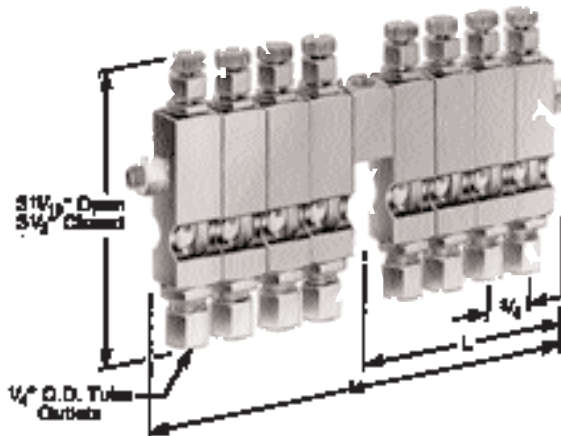

When Ordering Specify:

- Connector Kit for Multiple Sight Feed Valve Part Number A-5671-1



Sight Feed Valves with Shutoffs

ADJUSTABLE SIGHT FEED VALVES WITH TOGGLE SHUTOFF are widely used for gravity oiling systems where small quantities of liquid are to be dropped in. Their use can be extended to applications requiring adjustable, visual, flow control.

The needle valve permits fine adjustment over the entire range, from extremely low drop rate to a stream. The adjustments are retained by a friction lock. The toggle shuts off the flow completely, without interfering with the setting in any way. The sight chamber below the needle valve allows visual check of the feed rate and the venting of this chamber allows discharge by gravity.

SPECIFICATIONS:

- Pressure 125 P.S.I. Inlet to Drip Nozzle, Sight Chamber is Vented
- Temperature 225° F. Maximum
- Port 1/8 Dia.
- Body Aluminum Alloy
- Sight Glass
- Seals Buna-N

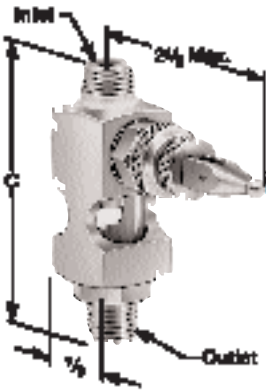

When Ordering Specify:
• Catalog Number

Catalog Number	Inlet N.P.T.	Outlet N.P.T.	C
B-1694-1	1/8 Fem.	1/8 Fem.	2 ⁷ / ₁₆
B-1694-2	1/8 Male	1/8 Male	2 ¹³ / ₁₆
B-1694-3	1/8 Fem.	1/8 Male	
B-1694-4	1/8 Male	1/8 Fem.	2 ⁷ / ₁₆
B-1694-5	1/8 Fem.	1/4 O.D. Tube	3
B-1694-6	1/8 Male	1/4 O.D. Tube	3
B-1694-8	1/4 Fem.	1/4 Fem.	2 ⁷ / ₁₆
B-1694-9	1/4 Male	1/4 Male	2 ⁷ / ₈
B-1694-10	1/4 Fem.	1/4 Male	2 ⁷ / ₈
B-1694-11	1/4 Male	1/4 Fem.	2 ⁷ / ₁₆
B-1694-12	1/4 Fem.	1/4 O.D. Tube	3
B-1694-13	1/4 Male	1/4 O.D. Tube	3
B-1694-17	5/8-18 Thd. 7/16-20 Fem. Thd.	1/8 Fem.	2 ⁹ / ₁₆
B-1694-18	1/8 Fem.	5/8-18 Thd. 1/8 Fem.	3 ³ / ₁₆

ADJUSTABLE SIGHT FEED VALVES WITH SOLENOID SHUTOFF permit shutoff of drop feeding without disturbing the selected adjustable flow rate. A Needle valve regulates liquid flow. Fine adjustments can be made and the sight chamber permits excellent observation of the liquid. The friction lock retains the setting. The solenoid is available in all voltages and frequencies and the coil is permanently molded into the housing, creating a very durable and water resistant construction.

The sight chamber of the valve is equipped with a vent. For applications requiring air tight sight chambers, solid gaskets can be provided.

SPECIFICATIONS:

- Pressure Inlet to Drip Nozzle
5 P.S.I. DC
10 P.S.I. AC
Sight is Vented
- Temperature 225° F. Maximum
- Port 1/8 Dia.
- Body Aluminum Alloy
- Sight Glass
- Seals Buna-N

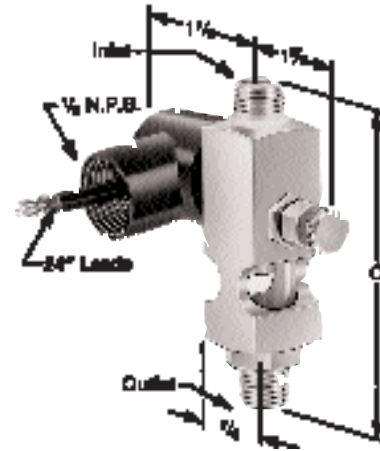

When Ordering Specify:

- Model Number
- Voltage and Frequency

Model Number	Inlet N.P.T.	Outlet N.P.T.	C
B-1835-1	1/8 Fem.	1/8 Fem.	2 ¹⁵ / ₁₆
B-1835-2	1/8 Male	1/8 Male	3 ⁵ / ₁₆
B-1835-3	1/8 Fem.	1/8 Male	
B-1835-4	1/8 Male	1/8 Fem.	2 ¹⁵ / ₁₆
B-1835-5	1/8 Fem.	1/4 O.D. Tube	3 ¹ / ₂
B-1835-6	1/8 Male	1/4 O.D. Tube	3 ¹ / ₂
B-1835-8	1/4 Fem.	1/4 Fem.	2 ¹⁵ / ₁₆
B-1835-9	1/4 Male	1/4 Male	3 ³ / ₈
B-1835-10	1/4 Fem.	1/4 Male	3 ³ / ₈
B-1835-11	1/4 Male	1/4 Fem.	2 ¹⁵ / ₁₆
B-1835-12	1/4 Fem.	1/4 O.D. Tube	3 ¹ / ₂
B-1835-13	1/4 Male	1/4 O.D. Tube	3 ¹ / ₂
B-1835-19	1/8 Fem.	5/8-18 Thd. 1/8 Fem.	3 ¹¹ / ₁₆
B-1835-20	5/8-18 Thd. 1/8 Fem.	1/8 Fem.	2 ⁷ / ₈

Constant Flow Control Valves & Solenoids

CONSTANT FLOW CONTROL VALVES have a fixed flow rate and can be equipped with orifices producing a specific flow rate ranging from 3 ounces per minute to 1 gallon per minute. The flow rate selected will remain constant within plus or minus 20% for 3 ounces to 9 ounces per minute, and within plus or minus 10 % for 1 pint to 1 gallon per minute. This accuracy will be retained with varying pressures, ranging from 15 PSI minimum to 125 PSI maximum, and with any oil having a viscosity of 400 SSU minimum to 750 SSU maximum.

Flow control valves are used in low pressure lubricating systems. They do not require frequent adjustment usually needed on ordinary valves and are, therefore, especially suitable for use in automated plants, for elevated, distant, or hard to get at places.

The cylinder in the body, as well as the piston and spring, can readily be removed due to the unique construction. This allows a piston with a certain orifice to be exchanged with a different one for changing the flow rate if necessary.

SPECIFICATIONS:

- Flow Rate Non Adjustable See Table
- Pressure 15 P.S.I. Minimum
125 P.S.I. Maximum
- Temperature 225° F. Maximum
- Oil Viscosity Between 400 SSU and 750 SSU
- Body Aluminum Alloy
- Piston Brass
- Seals Buna-N

Piston increases or decreases the area of the outlet port of the cylinder, furnishing a constant flow rate under varying pressure.

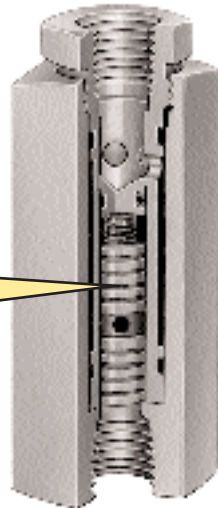

Style SPC

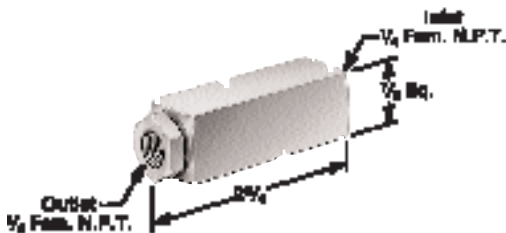

When Ordering Specify:
• Catalog Number

Catalog Number	Flow Rate Per Minute	Flow Tolerance	Orifice Size	
B-1844-1	3 OZ.	± 20%	.024	
B-1844-2	6 OZ.		.033	
B-1844-3	9 OZ.		.038	
B-1844-4	1 PT.	± 10%	.047	
B-1844-5	1QT.		.067	
B-1844-6	1/2 GAL.		.093	
B-1844-7	3/4 GAL.		.106	
B-1844-8				
B-1844-9	1 GAL.		.111	

SOLENOID VALVE OPERATORS are designed to achieve new standards of quality and reliability. The new operator is available in all voltages and frequencies. Construction is very rugged. The coil housings are steel, with a 1/2 NPS conduit connection.

The coil is permanently molded into the housing, creating a very durable, water resistant construction. The center core and plunger are stainless steel. Buna-N plunger seat and seals are standard. Ethylene propylene and Viton® - A seals are also available.

This operator has been designed to achieve an absolute minimum amount of maintenance and repair which has become increasingly important in the lubricating industry. Oil-Rite is completely confident in this new design and will warranty each unit against failure. A free replacement coil is offered for any coil that fails in the field. This is an exclusive feature of Oil-Rite.

This new operator is interchangeable with the following Oil-Rite electrically controlled lubrication dispensers, chain oiler and valves: DEY, DE, DEH, DEJ, DEF, DEC, SLVA, and SLV.

SPECIFICATIONS:

- Media Temperature -45° F. to +185° F.
- Nominal Power 7 Watts
- Coil Construction Class "B" +130° C. Water Resistant
- Coil Housing Steel
- Center Core Stainless Steel
- Plunger Stainless Steel
- Seals Buna-N, Ethylene Propylene, Viton®-A

Water Resistant molded coil.

Designed to achieve an absolute minimum amount of maintenance and repair.

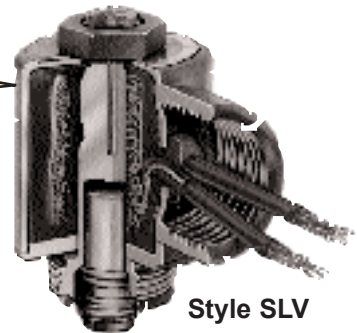

Style SLV

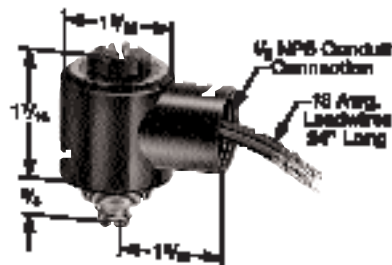

When Ordering Specify:
• Model Number
• Voltage and Frequency

Model Number	Seal Material
B-1725-1	Buna-N
B-1725-2	Viton®-A
B-1725-3	Ethylene Propylene

* Special - Please Consult Factory

© Viton is a registered trademark of Dupont Dow Corp.



Shutoff Valves & Precision Relief Valves

SOLENOID SHUTOFF VALVES are compact and suited for applications requiring rapid, positive, open and closed action in locations where space is a premium, hard to reach, or in automated plants. It operates in any position and is furnished with 1/4 pipe threads. The solenoid valve is normally closed. When current is applied to the solenoid, the valve port opens and it is automatically closed again when the current is shutoff. These valves are for continuous duty and flow cannot be adjusted.

They are available in all commercial voltages and frequencies. The coil is permanently molded into the housing, creating a very durable, water resistant construction.

Solenoid valves are usually pipe mounted. They are sturdy in construction, using aluminum alloy bodies and stainless steel plungers and springs. Buna-N seals are standard. Neoprene, Butyl, or Ethylene Propylene and Viton®-A seals are also available upon request.

SPECIFICATIONS:

Mechanical

- 2 Way Normally Closed
- NEMA 1 Enclosure
- Temperature 225° F. Maximum

Electrical

- Nominal Power 7 Watts
- Coil Construction Class "B" +130° C. Water Resistant

Materials

- Body Aluminum Alloy
- Seals Buna-N
- Optional Seals Ethylene Propylene, Viton®-A, Neoprene Butyl

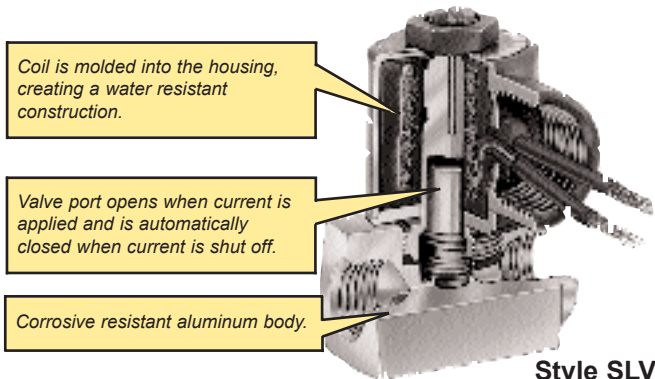

Style SLV

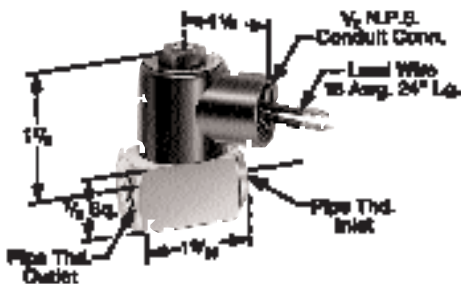

When Ordering Specify:

- Model Number
- Voltage and Frequency
- Seal Material

Model Number	Inlet N.P.T.	Outlet N.P.T.	Orifice Size	Maximum Pressure
B-1723-7	1/4 Fem.	1/4 Fem.	1/4	10 P.S.I.
B-1723-11	1/4 Fem.	1/4 Fem.	1/16	125 P.S.I.

PRECISION RELIEF VALVES meet the industry's requirements for more exacting and reliable performance. The relief valve has a fixed upper pressure rating which is held within close tolerances. In addition, relief pressures can be reduced and any setting locked. The setting for the upper limit is tamperproof and cannot be adjusted.

These units are used as a safety device on reservoirs where a certain maximum pressure should not be exceeded, or for any other application demanding pressure to be relieved at a specific value. The valves are offered in relief pressure ratings of 30 PSI and 60 PSI maximum. They have a 1/4 inch pipe thread.

The function of this device is simple. A plunger equipped with an O-ring is seated against a port inside the valve body. A spring holds the plunger to its seat. An enclosure cap is screwed over the valve body which is used to adjust the valve for the upper pressure limit. A vent hole on the top of the cap allows the escape of the released air or liquid. A locknut is provided on the valve body to lock the cap in place.

Units are installed by means of the pipe thread provided. To use the relief valve for the maximum rated pressure, screw the top cap down until seated and lock this setting with the locknut.

Should it be desirable to reset the valve for a lower pressure, it is only necessary to back off the top cap to a suitable point producing the desired pressure relief, and lock the setting with the locknut.

SPECIFICATIONS:

- Pressure Adjustable
- Temperature 225° F. Maximum
- Body Aluminum Alloy
- Piston Brass
- Seal Viton®-A
- Spring Stainless Steel

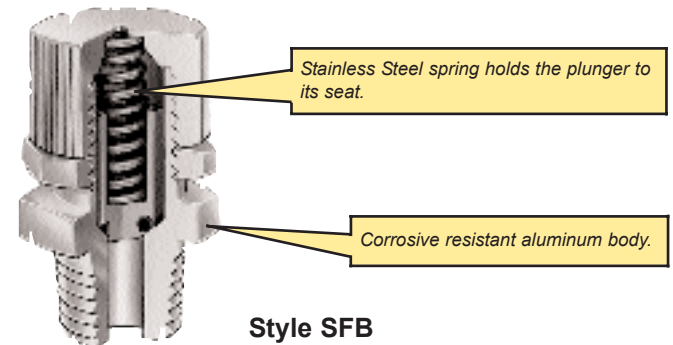

Style SFB

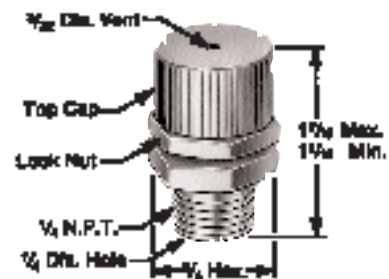

When Ordering Specify:

- Catalog Number

Catalog Number	Pressure Setting	
	Minimum	Maximum
A-4454-1	5 P.S.I.	30 ± 5 P.S.I.
A-4454-2	5 P.S.I.	60 ± 5 P.S.I.

© Viton is a registered trademark of Dupont Dow Corp.



P. O. BOX 1207, MANITOWOC, WI 54221-1207 (920) 682-6173 FAX (920) 682-7699
Internet <http://www.oilrite.com> e-mail sales@oilrite.com

Window Flow Sights

WINDOW FLOW SIGHTS WITH RESTRICTED ORIFICE dispense liquid at a fixed flow rate which is determined by the orifice selected.

The flow of liquid is downward through a nozzle in the transparent sight and can readily be observed. Pipe threads for inlet and outlet are provided. All units are normally furnished with a pressure tight sight.

These flow sights have many applications. They provide a simple, tamperproof method of furnishing the desired amount of lubrication for bearings without the use of control valves. The sights can be used as components in oiling systems and in a multitude of applications involving fluid transfer.

The construction is rigid. Bodies are machined from steel bar stock, and are plated. Buna-N seals are used. Inlet and outlet are offered in 1/8" or 1/4" female pipe threads. The sights are glass. There are four standard orifices available, ranging from 1/32" to 1/8" in diameter. Special orifices are available on request.

SPECIFICATIONS:

- Pressure 125 P.S.I. Maximum
- Temperature 225° F. Maximum
- Sight Glass-Pressure Tight Solid Gaskets
- Body Steel, Plated
- Seals Buna-N
- Orifice Brass

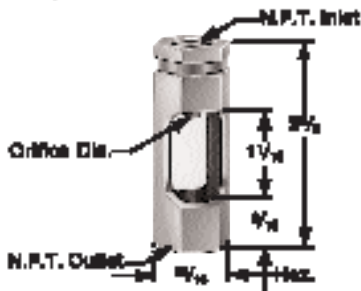
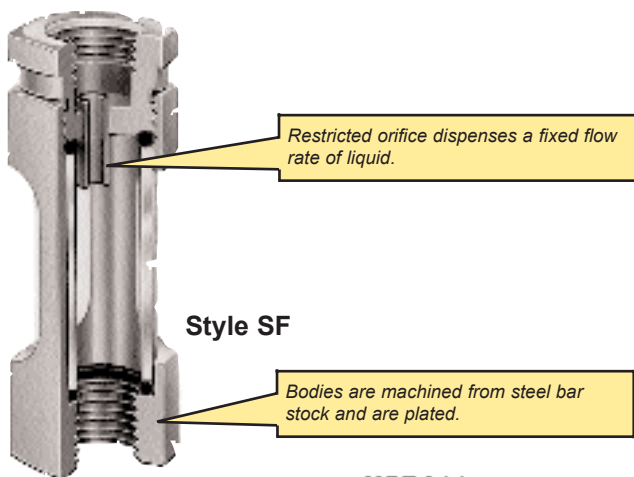

When Ordering Specify:

- Catalog Number

Flow values shown in table are approximate and are based on #20 oil at 70° F. at 10 P.S.I. and gravity discharge.

Catalog Number	Inlet N.P.T.	Outlet N.P.T.	Orifice Dia.	G.P.M.
* B-2252-1	1/8 Fem.	1/8 Fem.	1/32	.06
B-2252-2			1/16	.27
* B-2252-3	1/4 Fem.	1/4 Fem.	3/32	.61
B-2252-4			1/8	1.1

WINDOW FLOW SIGHTS FOR FULL FLOW offer no restrictions to the flow, permitting liquid to flow freely. The flow of liquid and its clarity can be visually observed through the sights. The units have an airtight sight chamber.

The Window Sights are primarily used in low pressure oil lines. There are no restrictions on the inside, therefore, no pressure drop, resulting in the full flow of liquid equal to respective pipe size. They can be installed in any position, either horizontally, vertically, or at an angle, and are offered in various pipe sizes.

Construction is simple and sturdy. Body is made from bar stock and is steel, plated. The sight is glass with Buna-N seals. Maximum recommended pressure is 125 P.S.I., and maximum temperature is 225° F.

There are five standard pipe thread sizes ranging from 1/8" to 3/4" female pipe thread. Larger sizes can be provided on request.

SPECIFICATIONS:

- Pressure 125 P.S.I. Maximum
- Temperature 225° F. Maximum
- Sight Glass-Pressure Tight Solid Gaskets
- Body Steel, Plated
- Seals Buna-N

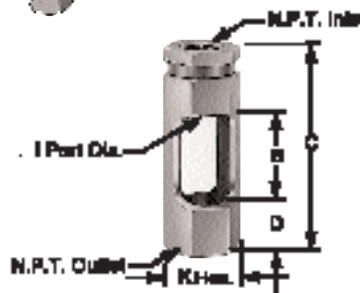
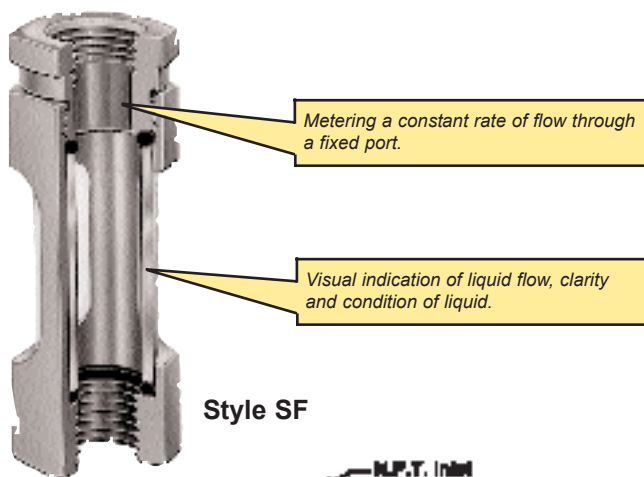

When Ordering Specify:

- Catalog Number

Liquid flow rate will be approximately equal to that for the respective pipe size.

Catalog Number	Inlet N.P.T.	Outlet N.P.T.	B	C	D	I	K
A-715-1	1/8 Fem.	1/8 Fem.	1 ¹ / ₁₆	2 ¹ / ₄	9 ¹ / ₁₆	11 ¹ / ₃₂	13 ¹ / ₁₆
A-715-2	1/4 Fem.	1/4 Fem.	1 ¹ / ₁₆	2 ¹ / ₄	9 ¹ / ₁₆	7 ¹ / ₁₆	13 ¹ / ₁₆
A-711-2	3/8 Fem.	3/8 Fem.	1 ³ / ₈	2 ¹ / ₈	3 ¹ / ₄	37 ¹ / ₆₄	15 ¹ / ₁₆
A-733-2	1/2 Fem.	1/2 Fem.	1 ³ / ₈	3 ⁵ / ₈	7 ¹ / ₈	9 ¹ / ₁₆	1 ¹ / ₁₆
A-2109-1	3/4 Fem.	3/4 Fem.	1 ¹ / ₂	3 ⁵ / ₁₆	15 ¹ / ₁₆	3 ¹ / ₄	1 ¹ / ₄

* Special - Please Consult Factory

Full Vision Flow & Over Flow Sights

FULL VISION FLOW SIGHTS WITH RESTRICTED ORIFICE are used in oil lines to check the flow of oil and its clarity by visual observation. The large size and construction permits maximum visibility and dependable inspection of liquid flow from a distance. They are often used at elevated heights to tell at a glance whether oil is circulating.

The flow of liquid is downward through a nozzle in the sight. All units are furnished with a removable vent plug. The sight chamber is normally vented when flow is discharged by gravity and closed when flow is discharged by low pressure.

SPECIFICATIONS:

- Pressure 125 P.S.I. Maximum for Acrylic
30 P.S.I. Maximum for Pyrex
- Temperature 160° F. Maximum Acrylic, 225° F. Maximum Pyrex
- Bodies Aluminum
- Sights Acrylic, except 1 1/8 Dia. which is Cellulose Acetate and Pyrex
- Seals Buna-N

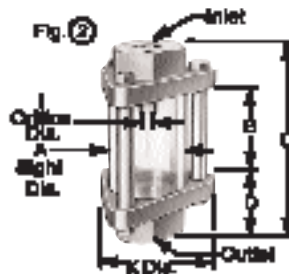
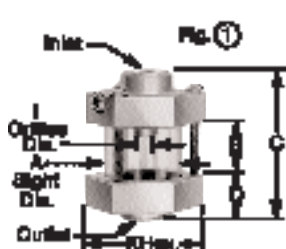
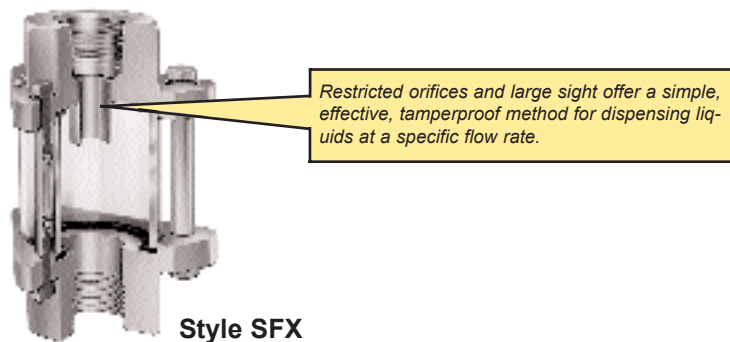
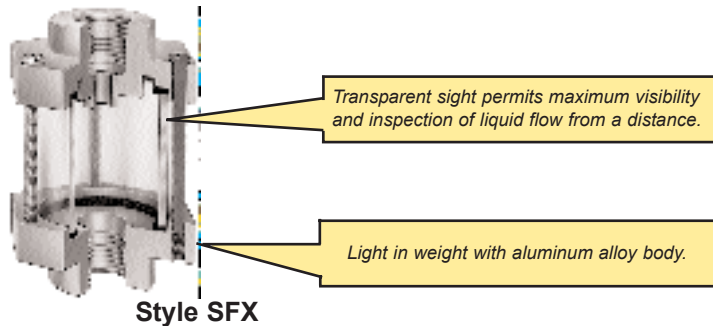

When Ordering Specify:
• Catalog Number

Catalog Number	Inlet N.P.T.	Outlet N.P.T.	Fig.	A	B	C	D	I	K	G.P.M.	
* B-1781-12	B-1781-22	1/4	1/4	1	1 1/8	3/4	2	5/8	5/32	1 1/2	1.7
* B-1766-4	B-1766-14	3/8	3/8	1	1 1/2	1 1/8	2 5/8	3/4	3/16	1 7/8	2.4
* B-1783-12	B-1783-22	1/2	1/2	1	2	1 5/8	3 3/4	1 1/16	5/16	2 1/2	6.7
B-1126-3	B-1126-13	1	1	2	2 1/2	2 1/8	5 5/16	1 19/32	5/8	4 3/8	16
B-1126-4	B-1126-14	1 1/4	1 1/4	2	2 1/2	2 1/8	5 5/16	1 19/32	5/8	4 3/8	26.9

OVER FLOW SIGHTS are used in oil lines of circulating systems to maintain a constant visible oil level. In addition, they permit checking of the liquid flow and clarity of liquid at a glance. Used mainly on large ring oil or reservoir type bearings of steam turbines or gear boxes, they can be used on many other applications.

The construction is lightweight with aluminum alloy bodies and acrylic sight chambers withstanding temperatures up to 160° F. Pyrex sights are available on request which withstand up to 225° F. Bolts and standpipe are steel, plated. Buna-N seals are standard. The unit is very rigid, but can be disassembled for cleaning if required.

SPECIFICATIONS:

- Pressure Low Pressure to Stand Pipe Gravity Discharge
- Temperature 160° F. Maximum
- Body Aluminum Alloy
- Sight Acrylic, Pyrex
- Seals Buna-N
- Stand Pipe Steel, Plated

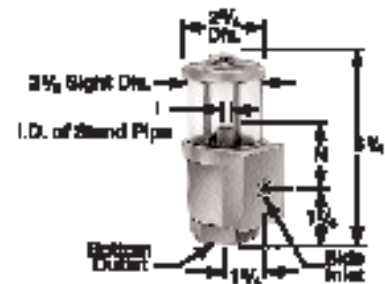

When Ordering Specify:
• Catalog Number

Catalog Number	Inlet N.P.T.	Outlet N.P.T.	I	N
B-239-1	1/2	1/2	9/16	1 7/8
B-239-2	3/4	3/4	13/16	
B-239-3	1	1	15/16	
B-239-4	1/2	1/2	9/16	1 1/2
‡ B-239-6	3/4	3/4	13/16	1 7/8

* Special - Please Consult Factory
‡ Pyrex Sight



P. O. BOX 1207, MANITOWOC, WI 54221-1207 (920) 682-6173 FAX (920) 682-7699
Internet <http://www.oilrite.com> e-mail sales@oilrite.com

